

# RESMED

## Swift™ FX Bella Gray

+ Swift™ FX HEADGEAR

NASAL PILLOWS SYSTEM

## User Guide

English



# RESMED

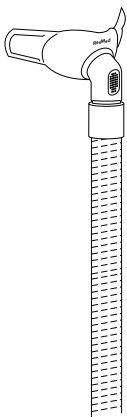
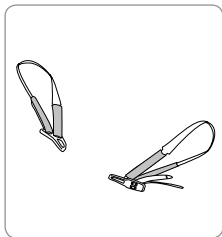

**Swift™ FX Bella Gray**

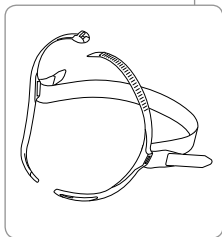
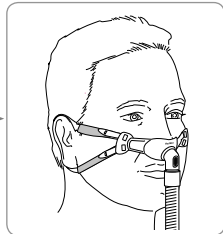

**Swift™ FX**

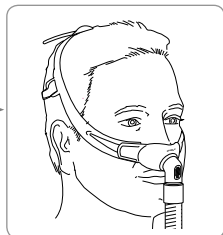

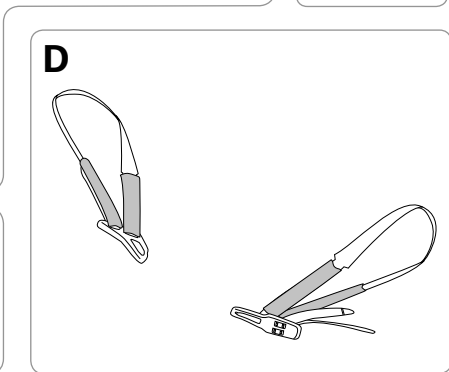
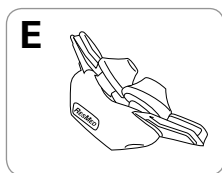
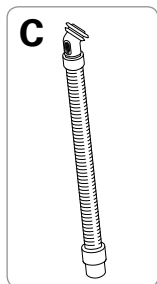
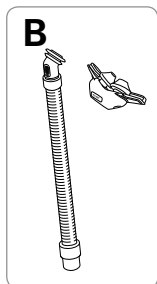
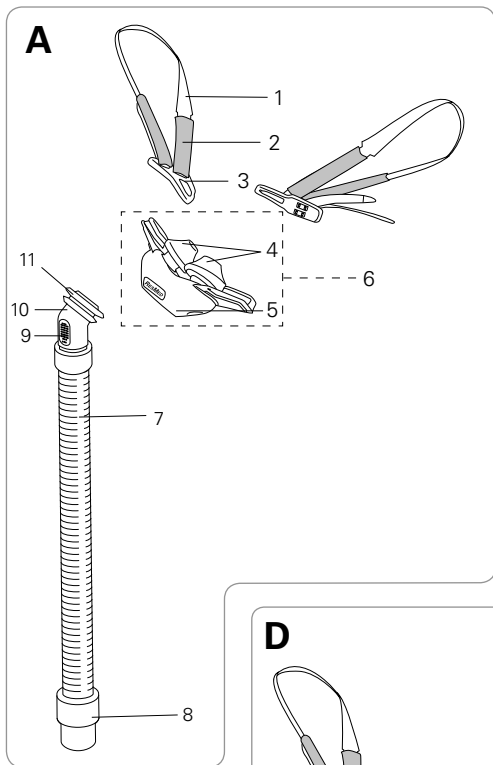

## Mask components / Maskenkomponenten / Composants du masque / Componenti della maschera / Maskeronderdelen

Item / Artikel / Désignation / Parte / Onderdeel	Description / Beschreibung / Description / Descrizione / Beschrijving	Part number / Teilenummer / Code produit / Numero parte / Onderdeelnummer
1	Strap / Band / Sangle / Cinghia / Band	—
2	Soft sleeve / Komforthüllen / Gaine souple / Guaina morbida / Zachte hoes	—
3	Buckle / Clip / Boucle / Fibbia / Gesp	—
4	Nasal pillows / Nasenpolster / Coussins narinaires / Cuscinetti nasali / Neuskussentjes	—
5	Cushion / Maskenkissen / Bulle / Cuscinetto / Kussentje	—
6	Pillows / Polster / Coussins / Cuscinetti / Kussentjes	—
7	Short tube / Verbindungsschlauch / Tuyau court / Tubo corto / Korte slang	—
8	Swivel / Drehadapter / Pièce pivotante / Giunto rotante / Draaibare kop	—
9	Vent / Luftauslassöffnung / Orifice de ventilation / Foro per l'esalazione / Ventilatieopening	—
10	Elbow / Kniestück / Coude / Gomito / Bocht	—
11	Swivel ring / Drehadapterring / Anneau pivotant / Anello rotante / Ring draaibare kop	—

Item / Artikel / Désignation / Parte / Onderdeel	Description / Beschreibung / Description / Descrizione / Beschrijving	Part number / Teilenummer / Code produit / Numero parte / Onderdeelnummer
A	Swift FX Bella Gray complete system / Swift FX Bella Gray Komplettsystem / Masque Swift FX Bella Gray complet / Cuscineti nasali Swift FX Bella Gray con tutti i componenti / Volledig Swift FX Bella Gray-systeem	61569 (EUR 1) 61572 (ANZ)
B	Pillows system (Frame system) / Nasenpolstermaske (Maskenhaltersystem) / Masque narinaire (support complet) / Cuscineti nasali (Telaio) / Kussentjessysteem (framesysteem)	61510 (XS) 61511 (S) 61512 (M) 61513 (L)
C	Short tube assembly (Frame assembly) / Verbindungsschlauch (Maskenhalter) / Ensemble tuyau court (ensemble support) / Gruppo circuito corto (Complesso del telaio) / Korte slang-assemblage (frame-assemblage)	61528 (1) 61527 (10)
D	Swift FX Bella Gray headgear assembly / Swift FX Bella Gray Kopfband / Ensemble harnais Swift FX Bella Gray / Gruppo del copricapo Swift FX Bella Gray / Assemblage Swift FX Bella Gray-hoofdbandenstel	61582 (1)
E	Pillows / Polster / Coussins / Cuscineti / Kussentjes	61521 (S) 61522 (M) 61523 (L)

Item / Artikel / Désignation / Parte / Onderdeel	Description / Beschreibung / Description / Descrizione / Beschrijving	Part number / Teilenummer / Code produit / Numero parte / Onderdeelnummer
<b>Also available / Außerdem erhältlich: / Également disponible / Altri prodotti /Tevens verkrijgbaar</b>		
	Pillows / Polster / Coussins / Cuscinetti / Kussentjes	61520 (XS)
	Swift FX Bella Gray + Swift FX headgear (Combination pack) / Swift FX Bella Gray + Swift FX Kopfband (Kombipackung) / Harnais Swift FX Bella Gray + Swift FX (kit combiné) / Copricapi Swift FX Bella Gray + Swift FX (Combinazione) / Swift FX Bella Gray- + Swift FX-hoofdbandenstel (combinatieverpakking)	61583

XS Extra Small / Extra Small / Très petit / Extra Small / Extra Small,  
 S Small / Small / Petit / Small / Small,  
 M Medium / Medium / Médium / Medium / Medium,  
 L Large / Large / Grand / Large / Large

# Fitting / Anlegen / Mise en place / Applicazione / Opzetten

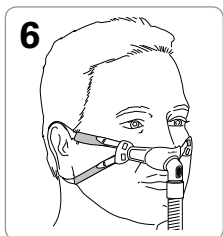
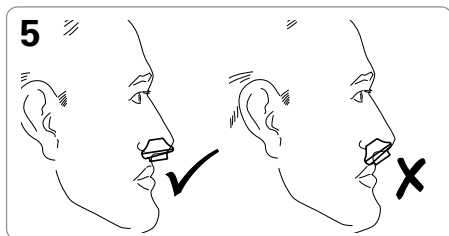
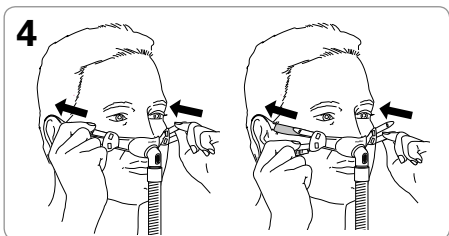
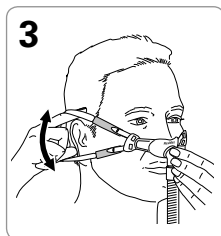
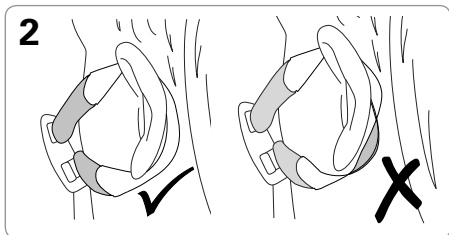
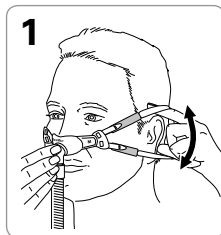

## Disassembly / Auseinanderbau / Démontage / Smontaggio / Demontage

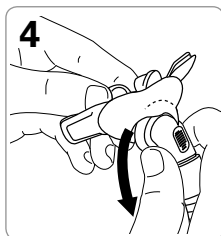
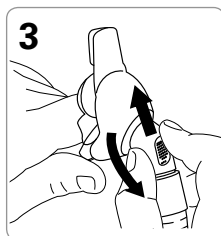
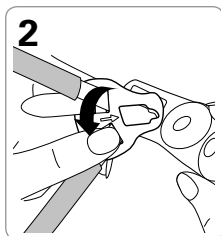
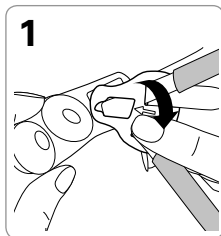



# Reassembly / Zusammenbau / Remontage / Riassemblaggio / Opnieuw monteren

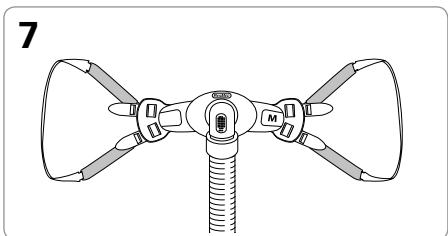
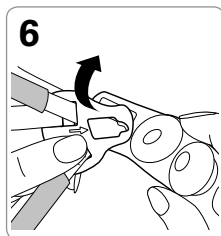
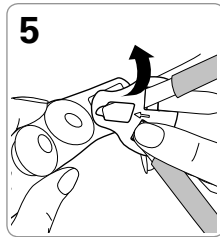
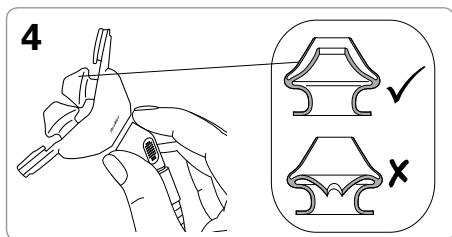
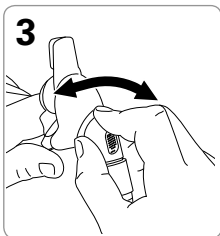
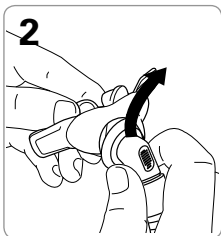
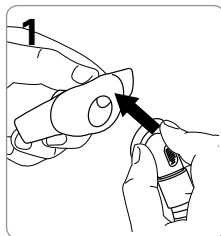

**Reassembly of straps (if required) /  
 Wiederanbringen der Bänder (falls erforderlich) /  
 Remontage des sangles (le cas échéant) /  
 Riassemblaggio delle cinghie (se richiesto) /  
 Opnieuw monteren van banden (indien nodig)**

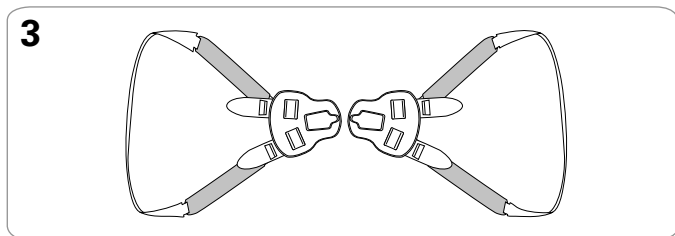
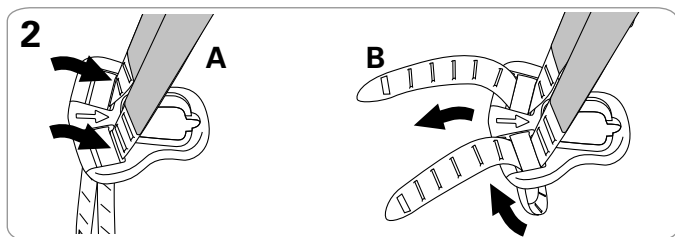
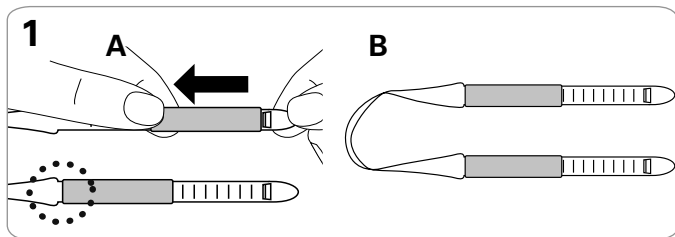

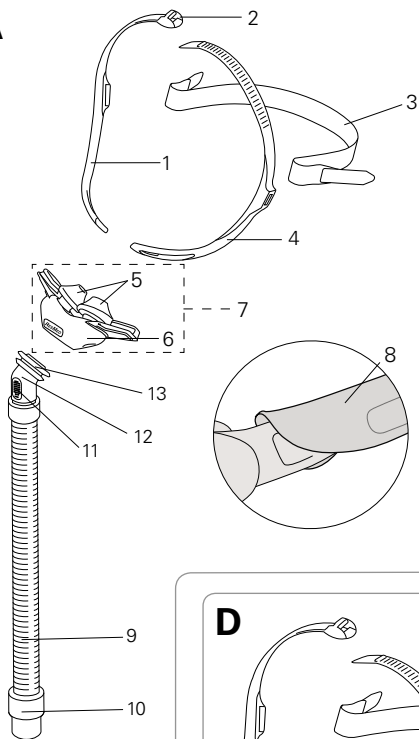
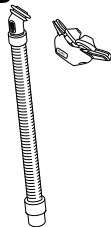
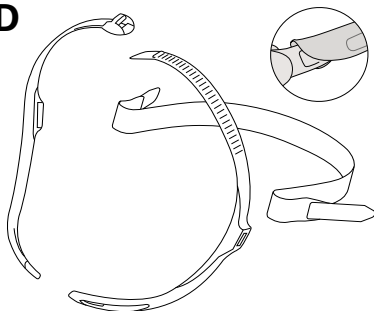
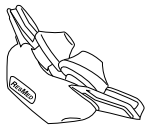
**A****B****C****D****E**

## Mask components / Maskenkomponenten / Composants du masque / Componenti della maschera / Maskeronderdelen

Item / Artikel / Désignation / Parte / Onderdeel	Description / Beschreibung / Description / Descrizione / Beschrijving	Part number / Teilenummer / Code produit / Numero parte / Onderdeelnummer
1	Headgear right / Kopfband rechts / Harnais droit / Parte destra copricapo / Rechterkant hoofdband	—
2	Top buckle / Oberer Clip / Boucle supérieure / Fibbia superiore / Bovenste hoofdbandgesp	—
3	Back strap (1) / Hinteres Band (1) / Sangle arrière (1) / Cinghia posteriore (1) / Achterste band (1)	—
4	Headgear left / Kopfband links / Harnais gauche / Parte sinistra copricapo / Linkerkant hoofdband	—
5	Nasal pillows / Nasenpolster / Coussins narinaires / Cuscinetti nasali / Neuskussentjes	—
6	Cushion / Maskenkissen / Bulle / Cuscinetto / Kussentje	—
7	Pillows / Polster / Coussins / Cuscinetti / Kussentjes	—
8	Soft wraps / Weiche Hüllen / Housses souples / Involucri imbottiti / Zachte beschermers	61530 (2)
9	Short tube / Verbindungsschlauch / Tuyau court / Tubo corto / Korte slang	—
10	Swivel / Drehadapter / Pièce pivotante / Giunto rotante / Draaibare kop	—

Item / Artikel / Désignation / Parte / Onderdeel	Description / Beschreibung / Description / Descrizione / Beschrijving	Part number / Teilenummer / Code produit / Numero parte / Onderdeelnummer
11	Vent / Luftauslassöffnung / Orifice de ventilation / Foro per l'esalazione / Ventilatieopening	—
12	Elbow / Kniestück / Coude / Gomito / Bocht	—
13	Swivel ring / Drehadapterring / Anneau pivotant / Anello rotante / Ring draibare kop	—
A	Swift FX complete system / Swift FX Komplettsystem / Masque Swift FX complet / Cuscineti nasali Swift FX con tutti i componenti / Volledig Swift FX-systeem	61501 (EUR 1) 61504 (ANZ)
B	Pillows system (Frame system) / Nasenpolstermaske (Maskenhaltersystem) / Masque narinaire (support complet) / Cuscineti nasali (Telaio) / Kussentjessysteem (framesysteem)	61510 (XS) 61511 (S) 61512 (M) 61513 (L)
C	Short tube assembly (Frame assembly) / Verbindungsschlauch (Maskenhalter) / Ensemble tuyau court (ensemble support) / Gruppo circuito corto (Complesso del telaio) / Korte slang-assemblage (frame-assemblage)	61528 (1) 61527 (10)
D	Swift FX headgear assembly / Swift FX Kopfband / Ensemble harnais Swift FX / Gruppo del copricapo Swift FX / Assemblage Swift FX-hoofdbandenstel	61529
E	Pillows / Polster / Coussins / Cuscineti / Kussentjes	61521 (S) 61522 (M) 61523 (L)

Item / Artikel / Désignation / Parte / Onderdeel	Description / Beschreibung / Description / Descrizione / Beschrijving	Part number / Teilenummer / Code produit / Numero parte / Onderdeelnummer
<b>Also available / Außerdem erhältlich: / Également disponible / Altri prodotti / Tevens verkrijgbaar</b>		
	Pillows / Polster / Coussins / Cuscinetti / Kussentjes	61520 (XS)
	Swift FX Bella Gray + Swift FX headgear (Combination pack) / Swift FX Bella Gray + Swift FX Kopfband (Kombipackung) / Harnais Swift FX Bella Gray + Swift FX (kit combiné) / Copricapi Swift FX Bella Gray + Swift FX (Combinazione) / Swift FX Bella Gray- + Swift FX-hoofdbandenstel (combinatieverpakking)	61583

XS Extra Small / Extra Small / Très petit / Extra Small / Extra Small,  
 S Small / Small / Petit / Small / Small,  
 M Medium / Medium / Médium / Medium / Medium,  
 L Large / Large / Grand / Large / Large

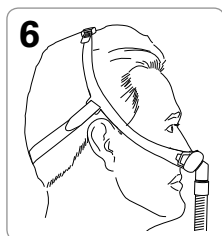
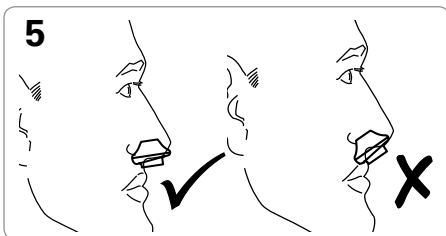
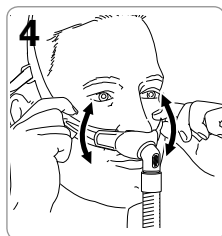
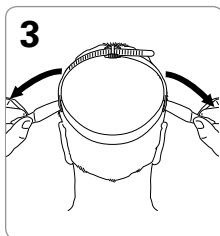
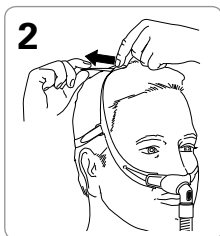
**Fitting / Anlegen / Mise en place / Applicazione / Opzetten**

## Disassembly / Auseinanderbau / Démontage / Smontaggio / Demontage

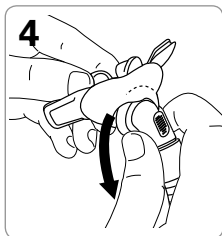
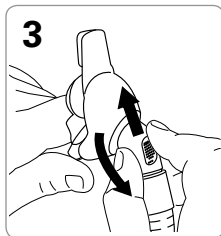
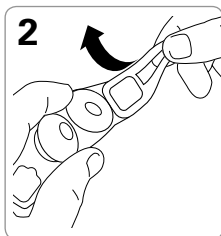
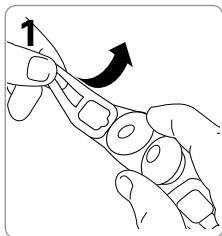

## Reassembly

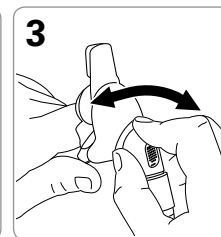
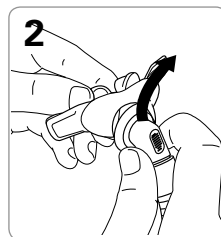
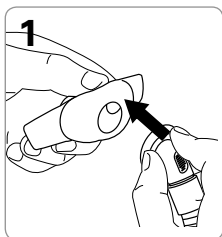



# Reassembly / Zusammenbau / Remontage / Riassemblaggio / Opnieuw monteren

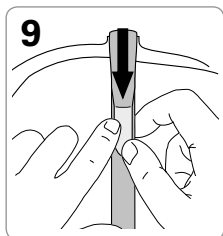
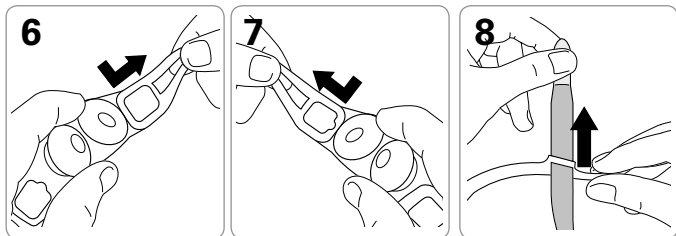
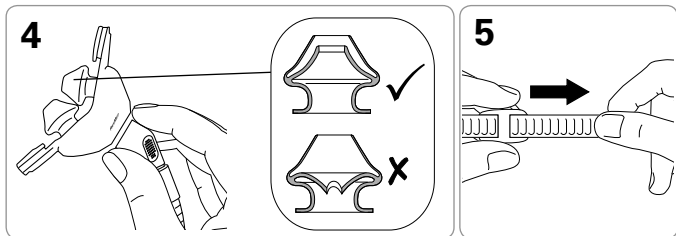

**English****Swift™ FX Bella Gray****+ Swift™ FX** HEADGEAR

## NASAL PILLOWS SYSTEM

Thank you for choosing the Swift FX Bella Gray + Swift FX Headgear. The Swift FX Bella Gray + Swift FX Headgear is the first of ResMed's Nasal Pillows Systems that offers a choice of two different types of headgear. This user guide provides you with instructions for setting up and using both headgear with your nasal pillows system.

**Intended use**

The Swift FX Bella Gray and Swift FX channels airflow noninvasively to a patient from a positive airway pressure (PAP) device such as a continuous positive airway pressure (CPAP) or bilevel system.

The Swift FX Bella Gray and Swift FX are:

- to be used by adult patients (>30 kg) for whom positive airway pressure has been prescribed
- intended for single-patient re-use in the home environment and multipatient re-use in the hospital/institutional environment.

**Using your mask**

When using your mask with ResMed CPAP or bilevel devices that have mask setting options, refer to the Technical specifications section in this user guide for mask selection options.

For a full list of compatible devices for these masks, see the Mask/Device Compatibility List on [www.resmed.com](http://www.resmed.com) on the **Products** page under **Service & Support**. If you do not have internet access, please contact your ResMed representative.

**Notes:**

- *These masks are not compatible for use with ResMed AutoSet CS™ 2 and VPAP™ Adapt SV devices.*
- *SmartStop may not operate effectively when using these masks with some CPAP or bilevel devices that have this feature.*
- *If you experience nasal dryness or irritation, use of a humidifier is recommended.*



## GENERAL WARNINGS

- The vent holes must be kept clear.
- The mask should only be used with CPAP or bilevel devices recommended by a physician or respiratory therapist.
- The mask should not be used unless the device is turned on. Once the mask is fitted, ensure the device is blowing air.

**Explanation:** CPAP and bilevel devices are intended to be used with special masks (or connectors) which have vent holes to allow continuous flow of air out of the mask. When the device is turned on and functioning properly, new air from the device flushes the exhaled air out through the mask vent holes. However, when the device is not operating, insufficient fresh air will be provided through the mask, and the exhaled air may be rebreathed. Rebreathing of exhaled air for longer than several minutes can, in some circumstances, lead to suffocation. This applies to most models of CPAP or bilevel devices.

- Follow all precautions when using supplemental oxygen.
- Oxygen flow must be turned off when the CPAP or bilevel device is not operating, so that unused oxygen does not accumulate within the CPAP or bilevel device enclosure and create a risk of fire.
- Oxygen supports combustion. Oxygen must not be used while smoking or in the presence of an open flame. Only use oxygen in well ventilated rooms.
- At a fixed rate of supplemental oxygen flow, the inhaled oxygen concentration varies, depending on the pressure settings, patient breathing pattern, mask, point of application and leak rate. This warning applies to most types of PAP devices.

- The technical specifications of the mask are provided for your clinician to check that they are compatible with the CPAP or bilevel device. If used outside specification or if used with incompatible devices, the seal and comfort of the mask may not be effective, optimum therapy may not be achieved, and leak, or variation in the rate of leak, may affect the CPAP or bilevel device function.
- Discontinue using the mask if you have ANY adverse reaction to the use of the mask, and consult your physician or sleep therapist.
- Using a mask may cause tooth, gum or jaw soreness or aggravate an existing dental condition. If symptoms occur, consult your physician or dentist.
- As with all masks, some rebreathing may occur at low CPAP pressures.
- Refer to your CPAP or bilevel device manual for details on settings and operational information.
- Remove all packaging before using the mask.

## Fitting

The Swift FX Bella Gray fitting illustrations in this user guide show the sequence for obtaining the best fit and comfort when using your mask.

---

### Fitting steps

---

1. Hold the pillows at your nose ensuring that the ResMed logo is on the top of the pillows facing up. Pull one strap around and behind your ear.
2. Ensure the strap lies flat and is not twisted.
3. Repeat steps 1 and 2 with the other strap.
4. Adjust the mask fit by pulling the upper straps along the notches until a comfortable fit is achieved. Repeat with the lower straps. Do not overtighten.
5. Check that the nasal pillows are positioned upright in the entrance of your nostrils.
6. Finally, connect the free end of the short tube assembly to the device air tubing. The mask is now fitted and ready for use.



### WARNING

Using Swift FX Bella Gray may cause ear soreness. If symptoms occur, consult your physician.

## Removing your mask

To remove your mask, place your fingers underneath the straps and lift them away from your ears.

## Disassembly

Refer to the Swift FX Bella Gray disassembly illustrations in this user guide.

---

### Disassembly steps

---

- 1–2. Remove each buckle by slightly twisting the buckle and pulling away from the node on the pillows.
- 3–4. Gently push the swivel ring up and pull out of the cushion.

**Note:** The strap and soft sleeve are not intended to be disassembled and can be washed together, while attached to the buckle.

## Reassembly

Refer to the Swift FX Bella Gray reassembly illustrations in this user guide.

---

### System reassembly steps

- 1–2. Insert the swivel ring into the opening of the cushion. Ensure that the cushion sits between the ridges of the swivel ring.
3. Rotate the elbow to ensure it moves freely.
4. Check that the inner walls of the nasal pillows are not compressed or collapsed. If so, squeeze each nasal pillow to release the inner wall.
5. Hold the buckle with the arrow facing you. Latch the buckle onto the node on the pillows.
6. Repeat step 5 with the other buckle.

---

### Headgear reassembly steps (if required)

If you have disassembled your headgear it needs to be reassembled before attaching to the pillows.

1. Thread each strap through the soft sleeve. Pull the soft sleeve up until it sits flush against the widest part of the strap. Ensure the soft sleeve lies flat on the strap.
2. Hold the buckle with the arrow facing up.
  - A. Ensuring the notches of the strap are facing the arrow head, thread the end of the strap down through the opening closest to the arrow head on the buckle.
  - B. Bring the end of the strap up through the other opening, making sure that the notches on the strap sit against each other.Repeat these steps with each strap.
3. Ensure that the straps are not twisted.

## Fitting

The Swift FX fitting illustrations in this user guide show the sequence for obtaining the best fit and comfort when using your mask.

---

### Fitting steps

---

1. Hold the pillows at your nose ensuring that the ResMed logo is on the top of the pillows facing up. Pull the headgear over your head. The headgear should sit midway between the ears and eyes.
2. Adjust the top straps by pulling the strap through the buckle, one notch at a time. Do not overtighten.
3. Adjust the side straps until a comfortable fit is achieved. The back strap can be positioned over or under the hair.
4. Adjust the headgear until the nasal pillows sits comfortably in your nose.
5. Check that the nasal pillows are positioned upright in the entrance of your nostrils.
6. Finally, connect the free end of the short tube assembly to the device air tubing.  
The mask is now fitted and ready for use.

## Removing your mask

To remove your mask loosen the upper strap, then pull the mask and headgear up over your head.

## Disassembly

Refer to the Swift FX disassembly illustrations in this user guide.

---

### Disassembly steps

---

- 1–2. Remove the headgear by slightly twisting each headgear arm and pulling away from the node on the pillows.
- 3–4. Gently push the swivel ring up and pull out of the cushion.

## Reassembling

Refer to the Swift FX reassembly illustrations in this user guide.

---

### Reassembly steps

---

- 1–2. Insert the swivel ring into the opening of the cushion. Ensure that the cushion sits between the ridges of the swivel ring.
3. Rotate the elbow to ensure it moves freely.
4. Check that the inner walls of the nasal pillows are not compressed or collapsed. If so, squeeze each nasal pillow to release the inner wall.
5. Thread the headgear strap through the top buckle.
6. Hold the headgear arm with the recess facing you. Latch the headgear arm onto the node on the pillows.
7. Repeat step 6 with the other headgear arm.
- 8–9. Thread the back strap through each side of the headgear, then fold over to secure. Ensure that the hook tab is on the outside.



## Cleaning your mask in your home

Your mask and headgear should only be handwashed by gently rubbing in warm (approximately 30°C) water using mild soap. All components should be rinsed well with drinking quality water and allowed to air dry out of direct sunlight.



### WARNING

Do not use aromatic-based solutions or scented oils (eg, eucalyptus or essential oils), bleach, alcohol or products that smell strongly (eg, citrus) to clean any of the mask components. Residual vapours from these solutions can be inhaled if not rinsed thoroughly. They may also damage the mask, causing cracks.



### CAUTION

- If any visible deterioration of a system component is apparent (cracking, crazing, tears or cushion damage), the component should be discarded and replaced.
- Avoid connecting flexible PVC products (eg, PVC tubing) directly to any part of the mask. Flexible PVC contains elements that can be detrimental to the materials of the mask, and may cause the components to crack or break.

#### Daily/After each use:

- To optimise the mask seal, facial oils should be removed from the cushion after use.
- Handwash the separated mask components (excluding headgear).
- If the vent requires cleaning use a soft bristle brush.

#### Weekly:

- Handwash the headgear. It may be washed without being disassembled.

## Reprocessing the mask between patients

This mask should be reprocessed when used between patients. Cleaning, disinfection and sterilisation instructions are available from the ResMed website, [www.resmed.com/masks/sterilization](http://www.resmed.com/masks/sterilization). If you do not have internet access, please contact your ResMed representative.

## Troubleshooting

### Problem / possible cause

### Solution

#### Pillows won't seal properly, are uncomfortable or cause red marks

Pillows may have been fitted incorrectly, adjusted incorrectly or the headgear is too tight.

Check that the ResMed logo on top of the pillows is facing outwards. Carefully follow the fitting instructions. Readjust the headgear to ensure it is not over tightened.

Inner wall position of one or both pillows is incorrect.

Squeeze pillow sides to release inner wall. The correct position is shown in the reassembly instructions.

Pillows are the wrong size.

Talk to your clinician.

Pillows may be dirty.

Clean pillows according to the instructions.

#### Mask is too noisy

System is assembled incorrectly.

Disassemble the mask, then reassemble according to the instructions.

System is leaking air.

Refit or reposition you mask. Adjust your headgear. Check your mask is assembled correctly.

Vent is blocked or partially blocked.

If the vent requires cleaning, use a soft bristle brush.

**Problem / possible cause****Solution****Ears are sore**

Swift FX Bella Gray headgear is not fitted correctly.

Readjust the straps to ensure they are not overtightened or twisted. If problem persists talk to your clinician.

Swift FX Bella Gray headgear is not suited for your ear type.

Replace the Swift FX Bella Gray headgear with the supplied Swift FX headgear.

**Technical specifications****Pressure-flow curve**

*The mask contains passive venting to protect against rebreathing. As a result of manufacturing variations, the vent flow rate may vary.*

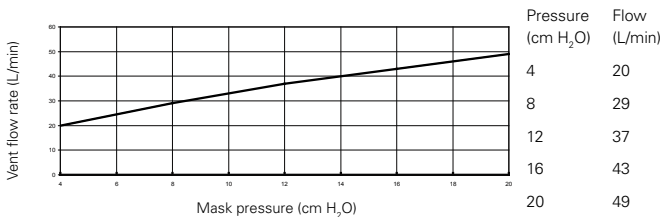
**Dead space information**

Physical dead space is the empty volume of the mask to the end of the swivel. Using the large cushions it is 106 mL.

**Therapy pressure**

4 to 20 cm H<sub>2</sub>O

**Resistance**

Drop in pressure measured (nominal)  
 at 50 L/min: 0.4 cm H<sub>2</sub>O  
 at 100 L/min: 1.4 cm H<sub>2</sub>O

**Environmental conditions**

Operating temperature: +5°C to +40°C  
 Operating humidity: 15% to 95% relative humidity non-condensing  
 Storage and transport temperature: -20°C to +60°C  
 Storage and transport humidity: up to 95% relative humidity non-condensing

## Technical specifications

<b>Sound</b>	DECLARED DUAL-NUMBER NOISE EMISSION VALUES in accordance with ISO 4871. The A-weighted sound power level of the mask is 25 dBA, with uncertainty 3 dBA. The A-weighted sound pressure level of the mask at a distance of 1m is 17 dBA, with uncertainty 3 dBA.
<b>Gross dimensions</b>	Large: 415 mm (H) x 94 mm (W) x 45 mm (D) Mask fully assembled with short tube assembly (no headgear)
<b>Mask setting options</b>	<b>For S9:</b> Select 'Pillows' <b>For other devices:</b> Select 'SWIFT' (if available), otherwise select 'MIRAGE' as the mask option.

### Notes:

- *The mask system does not contain PVC, DEHP or phthalates.*
- *This product does not contain natural rubber latex.*
- *The manufacturer reserves the right to change these specifications without notice.*













## Storage

Ensure that the mask is thoroughly clean and dry before storing it for any length of time. Store the mask in a dry place out of direct sunlight.

## Disposal

The mask does not contain any hazardous substances and may be disposed of with your normal household refuse.

## Symbols

 Caution, consult accompanying documents;  Batch code;  
 Catalogue number;  Temperature limitation;  Humidity limitation;  
 Does not contain natural rubber latex;  Manufacturer;  Indicates a Warning or Caution and alerts you to a possible injury or explains special measures for the safe and effective use of the device;  Keep away from rain;  
 This way up;  Fragile, handle with care;  European Authorized Representative;

## **Consumer Warranty**

ResMed acknowledges all consumer rights granted under the EU Directive 1999/44/EG and the respective national laws within the EU for products sold within the European Union.



**Manufacturer:**

ResMed Ltd 1 Elizabeth Macarthur Drive Bella Vista NSW 2153 Australia.

**Distributed by:**

ResMed Corp 9001 Spectrum Center Boulevard San Diego CA 92123 USA.

ResMed (UK) Ltd 96 Milton Park Abingdon Oxfordshire OX14 4RY UK.

See [www.resmed.com](http://www.resmed.com) for other ResMed locations worldwide.

For patent information, see [www.resmed.com/ip](http://www.resmed.com/ip).

Swift is a trademark of ResMed Ltd and is registered in U.S. Patent and Trademark Office.



© 2012 ResMed Ltd.

**CE**  
0123



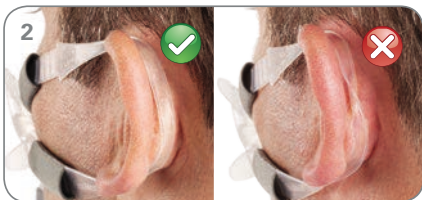

618259/1 2012-11

Swift FX Bella Gray +  
Swift FX Headgear

USER

EUR1 ENG



618259

**Swift™ FX Bella Gray**  
NASAL PILLOWS SYSTEM